

PLANAR CORES

Cores

- EL11X4 to EL25X8.6
- ELT11X3 to ELT25X8.6
- PQI16/7.8 to PQI26/11.5
- EIR14/4.5/9 to EIR22/5.5/15
- ER14/4.5/9 to ER25/5.5/18
- EI14/5/5 to EI22/8/16

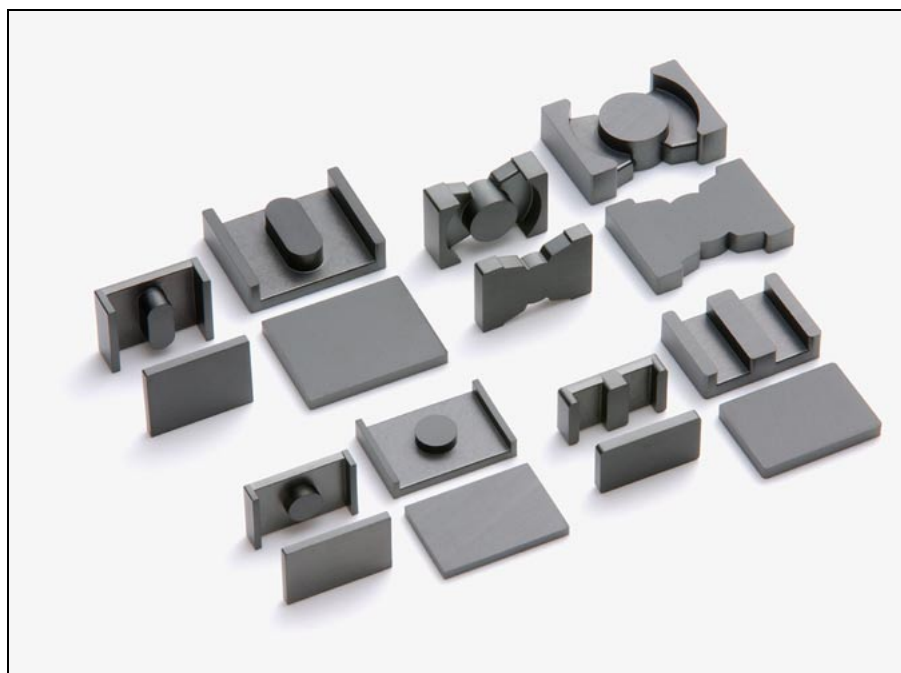

Ordering Code System

Cores

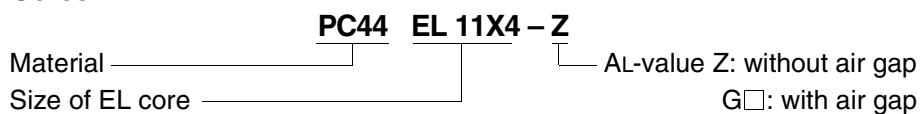

EL CORES

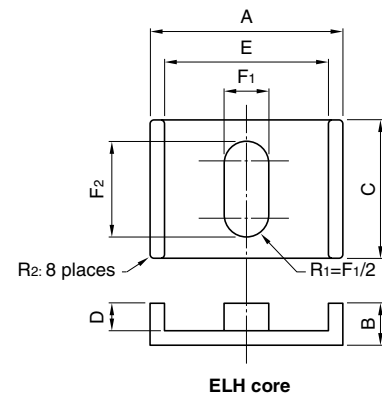
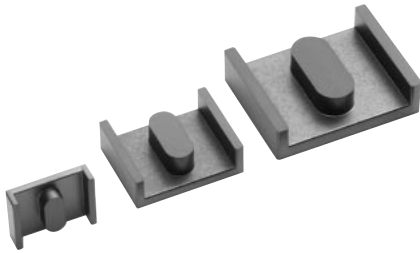

Part No. (ELH+ELH)	Dimensions in		C	D	E	F1	F2	R2
	A	B						
PC44EL11X4-Z								
PC47EL11X4-Z	11.00±0.20	2.01±0.10	8.80±0.20	1.00±0.10	9.17±0.20	2.78±0.10	6.40±0.15	0.30
PC95EL11X4-Z	.433±.008	.079±.004	.346±.008	.039±.004	.361±.008	.109±.004	.252±.006	.012
PC50EL11X4-Z								
PC33EL11X4-Z								
PC44EL13X4.4-Z								
PC47EL13X4.4-Z	13.00±0.25	2.19±0.10	10.40±0.20	1.00±0.10	10.83±0.20	3.29±0.10	7.56±0.15	0.30
PC95EL13X4.4-Z	.512±.010	.086±.004	.409±.008	.039±.004	.426±.008	.130±.004	.298±.006	.012
PC50EL13X4.4-Z								
PC33EL13X4.4-Z								
PC44EL15.5X5.8-Z								
PC47EL15.5X5.8-Z	15.50±0.30	2.92±0.10	12.40±0.25	1.50±0.10	12.92±0.25	3.92±0.10	9.01±0.20	0.30
PC95EL15.5X5.8-Z	.610±.012	.115±.004	.488±.010	.059±.004	.509±.010	.154±.004	.355±.008	.012
PC50EL15.5X5.8-Z								
PC33EL15.5X5.8-Z								
PC44EL18X7.3-Z								
PC47EL18X7.3-Z	18.00±0.30	3.65±0.10	14.40±0.25	2.00±0.10	15.00±0.30	4.55±0.10	10.47±0.20	0.30
PC95EL18X7.3-Z	.709±.012	.144±.004	.567±.010	.079±.004	.591±.012	.179±.004	.412±.008	.012
PC50EL18X7.3-Z								
PC33EL18X7.3-Z								

Part No. (ELH+ELH)	Effective parameter							Electrical characteristics	
	C ₁	ℓ _e	A _e	V _e	A _{min.}	A _{cw}	W _t	AL-value (nH/N ²) [*]	
	(mm ⁻¹)	(mm)	(mm ²)	(mm ³)	(mm ²)	(mm ²)	(g)	Without air gap	With air gap
PC44EL11X4-Z								2040±25%	
PC47EL11X4-Z								2040±25%	50±3%
PC95EL11X4-Z	0.826	13.7	16.5	226	15.9	6.39	1.3	2400±25%	80±5%
PC50EL11X4-Z								1470±25%	125±7%
PC33EL11X4-Z								1470±25%	530±15%**
PC44EL13X4.4-Z								2670±25%	
PC47EL13X4.4-Z								2670±25%	63±3%
PC95EL13X4.4-Z	0.667	15.4	23.1	357	22.4	7.54	2.0	3160±25%	100±5%
PC50EL13X4.4-Z								1890±25%	160±7%
PC33EL13X4.4-Z								1890±25%	720±15%**
PC44EL15.5X5.8-Z								3080±25%	
PC47EL15.5X5.8-Z								3080±25%	63±3%
PC95EL15.5X5.8-Z	0.597	19.6	32.9	646	31.9	13.5	3.5	3680±25%	100±3%
PC50EL15.5X5.8-Z								2250±25%	160±5%
PC33EL15.5X5.8-Z								2250±25%	990±15%**
PC44EL18X7.3-Z								3800±25%	
PC47EL18X7.3-Z								3800±25%	80±3%
PC95EL18X7.3-Z	0.538	23.8	44.3	1050	43.0	20.9	6.0	4760±25%	125±3%
PC50EL18X7.3-Z								2400±25%	200±5%
PC33EL18X7.3-Z								2400±25%	1280±15%**

* AL-value: 1kHz, 0.5mA, 100Ts

** Only PC95 material

EL CORES

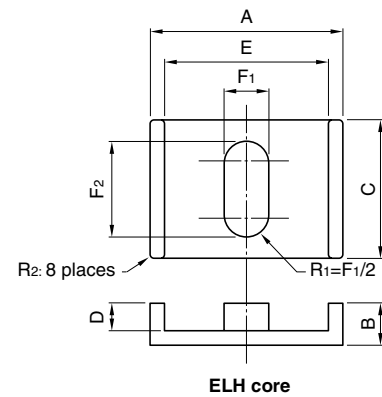
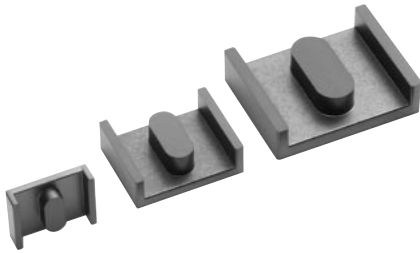

Part No. (ELH+ELH)	Dimensions in		C	D	E	F1	F2	R2
	mm	inches						
PC44EL20X7.7-Z								
PC47EL20X7.7-Z	20.00±0.35	3.83±0.10	16.00±0.30	2.00±0.10	16.67±0.30	5.06±0.15	11.63±0.20	0.50
PC95EL20X7.7-Z	.787±.014	.151±.004	.630±.012	.079±.004	.656±.012	.199±.006	.458±.008	.020
PC50EL20X7.7-Z								
PC33EL20X7.7-Z								
PC44EL22X8-Z								
PC47EL22X8-Z	22.00±0.40	4.02±0.10	17.60±0.30	2.00±0.10	18.33±0.35	5.56±0.15	12.79±0.25	0.50
PC95EL22X8-Z	.866±.016	.158±.004	.693±.012	.079±.004	.722±.014	.219±.006	.504±.010	.020
PC50EL22X8-Z								
PC33EL22X8-Z								
PC44EL25X8.6-Z								
PC47EL25X8.6-Z	25.00±0.45	4.29±0.10	20.00±0.35	2.00±0.10	20.83±0.35	6.32±0.15	14.54±0.25	0.50
PC95EL25X8.6-Z	.984±.018	.169±.004	.787±.014	.079±.004	.820±.014	.249±.006	.572±.010	.020
PC50EL25X8.6-Z								
PC33EL25X8.6-Z								

Part No. (ELH+ELH)	Effective parameter							Electrical characteristics	
	C ₁	ℓ _e	A _e	V _e	A _{min.}	A _{cw}	Wt	AL-value (nH/N ²)*	
	(mm ⁻¹)	(mm)	(mm ²)	(mm ³)	(mm ²)	(mm ²)	(g)	Without air gap	With air gap
PC44EL20X7.7-Z								4340±25%	80±3%
PC47EL20X7.7-Z								4340±25%	125±3%
PC95EL20X7.7-Z	0.469	25.6	54.6	1400	52.9	23.2	7.8	5630±25%	200±5%
PC50EL20X7.7-Z								2800±25%	1560±15%**
PC33EL20X7.7-Z								2800±25%	
PC44EL22X8-Z								5280±25%	100±3%
PC47EL22X8-Z								5280±25%	160±3%
PC95EL22X8-Z	0.413	27.3	66.2	1810	64.2	25.5	10	6540±25%	250±5%
PC50EL22X8-Z								3240±25%	1850±15%**
PC33EL22X8-Z								3240±25%	
PC44EL25X8.6-Z								6110±25%	100±3%
PC47EL25X8.6-Z								6110±25%	160±3%
PC95EL25X8.6-Z	0.350	30.0	85.6	2570	83.0	29.0	15	7540±25%	250±5%
PC50EL25X8.6-Z								4090±25%	2350±15%**
PC33EL25X8.6-Z								4090±25%	

* AL-value: 1kHz, 0.5mA, 100Ts

** Only PC95 material

ELT CORES

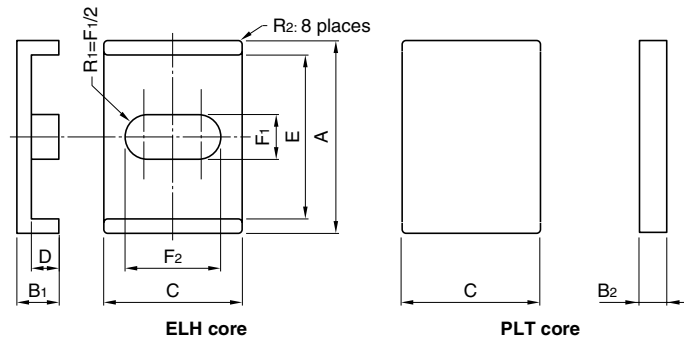
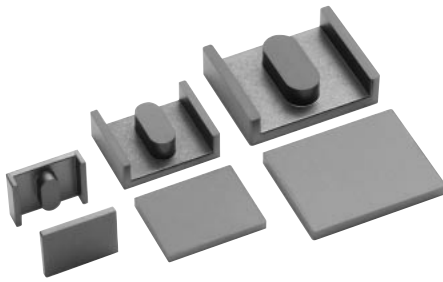

Part No. (ELH+PLT)	Dimensions in								
	A	B ₁	B ₂	C	D	E	F ₁	F ₂	R ₂
PC44ELT11X3-Z									
PC47ELT11X3-Z	11.00±0.20	2.01±0.10	1.01±0.05	8.80±0.20	1.00±0.10	9.17±0.20	2.78±0.10	6.40±0.15	0.30
PC95ELT11X3-Z	.433±.008	.079±.004	.040±.002	.346±.008	.039±.004	.361±.008	.109±.004	.252±.006	.012
PC50ELT11X3-Z									
PC33ELT11X3-Z									
PC44ELT11X4-Z									
PC47ELT11X4-Z	11.00±0.20	3.01±0.10	1.01±0.05	8.80±0.20	2.00±0.10	9.17±0.20	2.78±0.10	6.40±0.15	0.30
PC95ELT11X4-Z	.433±.008	.119±.004	.040±.002	.346±.008	.079±.004	.361±.008	.109±.004	.252±.006	.012
PC50ELT11X4-Z									
PC33ELT11X4-Z									
PC44ELT13X3.4-Z									
PC47ELT13X3.4-Z	13.00±0.25	2.19±0.10	1.19±0.05	10.40±0.20	1.00±0.10	10.83±0.20	3.29±0.10	7.56±0.15	0.30
PC95ELT13X3.4-Z	.512±.010	.086±.004	.047±.002	.409±.008	.039±.004	.426±.008	.130±.004	.298±.006	.012
PC50ELT13X3.4-Z									
PC33ELT13X3.4-Z									
PC44ELT13X4.4-Z									
PC47ELT13X4.4-Z	13.00±0.25	3.19±0.10	1.19±0.05	10.40±0.20	2.00±0.10	10.83±0.20	3.29±0.10	7.56±0.15	0.30
PC95ELT13X4.4-Z	.512±.010	.126±.004	.047±.002	.409±.008	.079±.004	.426±.008	.130±.004	.298±.006	.012
PC50ELT13X4.4-Z									
PC33ELT13X4.4-Z									

Part No. (ELH+PLT)	Effective parameter							Electrical characteristics	
	C ₁	g _e	A _e	V _e	A _{min.}	A _{cw}	Wt	AL-value (nH/N ²)*	
	(mm ⁻¹)	(mm)	(mm ²)	(mm ³)	(mm ²)	(mm ²)	(g)	Without air gap	With air gap
PC44ELT11X3-Z								2100±25%	
PC47ELT11X3-Z								2100±25%	50±3%
PC95ELT11X3-Z	0.702	11.7	16.6	194	15.9	3.20	1.1	2590±25%	80±5%
PC50ELT11X3-Z								1640±25%	125±7%
PC33ELT11X3-Z								1640±25%	540±15%**
PC44ELT11X4-Z								2040±25%	
PC47ELT11X4-Z								2040±25%	50±3%
PC95ELT11X4-Z	0.826	13.7	16.5	226	15.9	6.39	1.3	2400±25%	80±5%
PC50ELT11X4-Z								1470±25%	125±7%
PC33ELT11X4-Z								1470±25%	530±15%**
PC44ELT13X3.4-Z								2800±25%	
PC47ELT13X3.4-Z								2800±25%	63±3%
PC95ELT13X3.4-Z	0.578	13.4	23.2	312	22.4	3.77	1.8	3390±25%	100±5%
PC50ELT13X3.4-Z								2090±25%	160±7%
PC33ELT13X3.4-Z								2090±25%	740±15%**
PC44ELT13X4.4-Z								2670±25%	
PC47ELT13X4.4-Z								2670±25%	63±3%
PC95ELT13X4.4-Z	0.667	15.4	23.1	357	22.4	7.54	2.0	3160±25%	100±5%
PC50ELT13X4.4-Z								1890±25%	160±7%
PC33ELT13X4.4-Z								1890±25%	720±15%**

* AL-value: 1kHz, 0.5mA, 100Ts

** Only PC95 material

ELT CORES

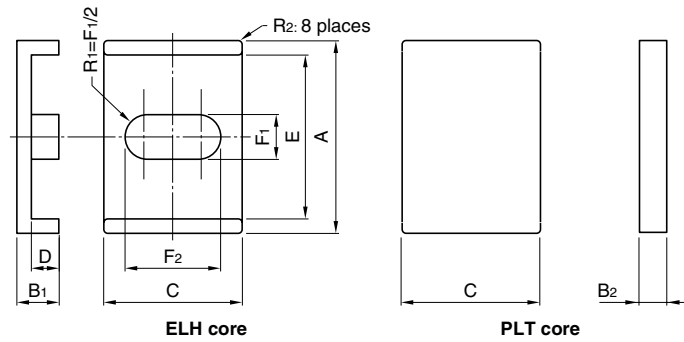
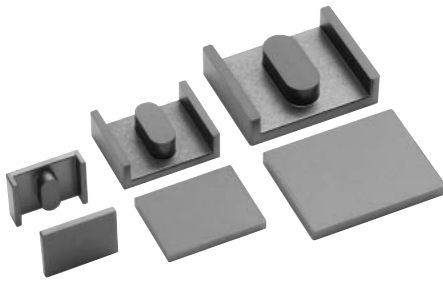

Part No. (ELH+PLT)	Dimensions in <small>mm</small> <small>inches</small>								
	A	B ₁	B ₂	C	D	E	F ₁	F ₂	R ₂
PC44ELT15.5X4.3-Z									
PC47ELT15.5X4.3-Z	15.50±0.30	2.92±0.10	1.42±0.10	12.40±0.25	1.50±0.10	12.92±0.25	3.92±0.10	9.01±0.20	0.30
PC95ELT15.5X4.3-Z	.610±.012	.115±.004	.056±.004	.488±.010	.059±.004	.509±.010	.154±.004	.355±.008	.012
PC50ELT15.5X4.3-Z									
PC33ELT15.5X4.3-Z									
PC44ELT15.5X5.8-Z									
PC47ELT15.5X5.8-Z	15.50±0.30	4.42±0.10	1.42±0.10	12.40±0.25	3.00±0.10	12.92±0.25	3.92±0.10	9.01±0.20	0.30
PC95ELT15.5X5.8-Z	.610±.012	.174±.004	.056±.004	.488±.010	.118±.004	.509±.010	.154±.004	.355±.008	.012
PC50ELT15.5X5.8-Z									
PC33ELT15.5X5.8-Z									
PC44ELT18X5.3-Z									
PC47ELT18X5.3-Z	18.00±0.30	3.65±0.10	1.65±0.10	14.40±0.25	2.00±0.10	15.00±0.30	4.55±0.10	10.47±0.20	0.30
PC95ELT18X5.3-Z	.709±.012	.144±.004	.065±.004	.567±.010	.079±.004	.591±.012	.179±.004	.412±.008	.012
PC50ELT18X5.3-Z									
PC33ELT18X5.3-Z									
PC44ELT18X7.3-Z									
PC47ELT18X7.3-Z	18.00±0.30	5.65±0.10	1.65±0.10	14.40±0.25	4.00±0.15	15.00±0.30	4.55±0.10	10.47±0.20	0.30
PC95ELT18X7.3-Z	.709±.012	.222±.004	.065±.004	.567±.010	.157±.006	.591±.012	.179±.004	.412±.008	.012
PC50ELT18X7.3-Z									
PC33ELT18X7.3-Z									

Part No. (ELH+PLT)	Effective parameter							Electrical characteristics	
	C ₁ (mm ⁻¹)	ρ _e (mm)	A _e (mm ²)	V _e (mm ³)	A _{min.} (mm ²)	A _{cw} (mm ²)	Wt (g)	AL-value (nH/N ²)*	
								Without air gap	With air gap
PC44ELT15.5X4.3-Z								3450±25%	
PC47ELT15.5X4.3-Z								3450±25%	63±3%
PC95ELT15.5X4.3-Z	0.503	16.6	33.1	550	31.9	6.75	3.0	4340±25%	100±3%
PC50ELT15.5X4.3-Z								2560±25%	160±5%
PC33ELT15.5X4.3-Z								2560±25%	1020±15%**
PC44ELT15.5X5.8-Z								3080±25%	63±3%
PC47ELT15.5X5.8-Z								3080±25%	100±3%
PC95ELT15.5X5.8-Z	0.597	19.6	32.9	646	31.9	13.5	3.5	3680±25%	160±5%
PC50ELT15.5X5.8-Z								2250±25%	
PC33ELT15.5X5.8-Z								2250±25%	990±15%**
PC44ELT18X5.3-Z								4200±25%	80±3%
PC47ELT18X5.3-Z								4200±25%	125±3%
PC95ELT18X5.3-Z	0.446	19.8	44.5	882	43.0	10.5	5.0	5330±25%	200±5%
PC50ELT18X5.3-Z								2750±25%	
PC33ELT18X5.3-Z								2750±25%	1330±15%**
PC44ELT18X7.3-Z								3800±25%	80±3%
PC47ELT18X7.3-Z								3800±25%	125±3%
PC95ELT18X7.3-Z	0.538	23.8	44.3	1050	43.0	20.9	6.0	4760±25%	200±5%
PC50ELT18X7.3-Z								2400±25%	
PC33ELT18X7.3-Z								2400±25%	1280±15%**

* AL-value: 1kHz, 0.5mA, 100Ts

** Only PC95 material

ELT CORES

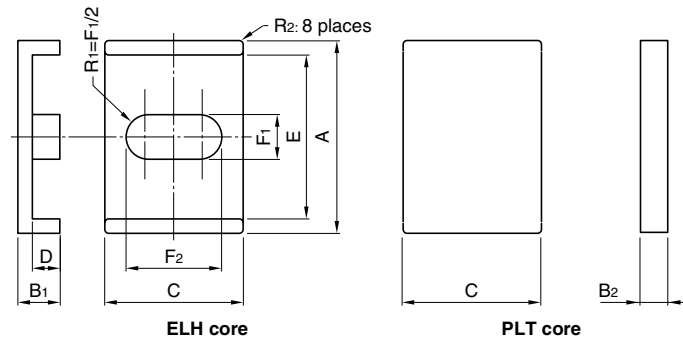
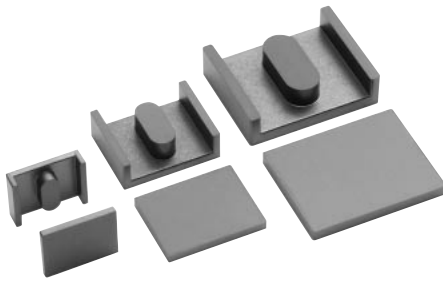

Part No. (ELH+PLT)	Dimensions in								
	A	B1	B2	C	D	E	F1	F2	R2
PC44ELT20X5.7-Z									
PC47ELT20X5.7-Z	20.00±0.35	3.83±0.10	1.83±0.10	16.00±0.30	2.00±0.10	16.67±0.30	5.06±0.15	11.63±0.20	0.50
PC95ELT20X5.7-Z	.787±.014	.151±.004	.072±.004	.630±.012	.079±.004	.656±.012	.199±.006	.458±.008	.020
PC50ELT20X5.7-Z									
PC33ELT20X5.7-Z									
PC44ELT20X7.7-Z									
PC47ELT20X7.7-Z	20.00±0.35	5.83±0.15	1.83±0.10	16.00±0.30	4.00±0.15	16.67±0.30	5.06±0.15	11.63±0.20	0.50
PC95ELT20X7.7-Z	.787±.014	.230±.006	.072±.004	.630±.012	.157±.006	.656±.012	.199±.006	.458±.008	.020
PC50ELT20X7.7-Z									
PC33ELT20X7.7-Z									
PC44ELT22X6-Z									
PC47ELT22X6-Z	22.00±0.40	4.02±0.10	2.02±0.10	17.60±0.30	2.00±0.10	18.33±0.35	5.56±0.15	12.79±0.25	0.50
PC95ELT22X6-Z	.866±.016	.158±.004	.080±.004	.693±.012	.079±.004	.722±.014	.219±.006	.504±.010	.020
PC50ELT22X6-Z									
PC33ELT22X6-Z									
PC44ELT22X8-Z									
PC47ELT22X8-Z	22.00±0.40	6.02±0.15	2.02±0.10	17.60±0.30	4.00±0.15	18.33±0.35	5.56±0.15	12.79±0.25	0.50
PC95ELT22X8-Z	.866±.016	.237±.006	.080±.004	.693±.012	.157±.006	.722±.014	.219±.006	.504±.010	.020
PC50ELT22X8-Z									
PC33ELT22X8-Z									

Part No. (ELH+PLT)	Effective parameter							Electrical characteristics	
	C ₁	ϕ _e	A _e	V _e	A _{min.}	A _{cw}	Wt	AL-value (nH/N ²)*	
	(mm ⁻¹)	(mm)	(mm ²)	(mm ³)	(mm ²)	(mm ²)	(g)	Without air gap	With air gap
PC44ELT20X5.7-Z								5000±25%	80±3%
PC47ELT20X5.7-Z								5000±25%	125±3%
PC95ELT20X5.7-Z	0.393	21.6	54.9	1180	52.9	11.6	6.7	6270±25%	200±5%
PC50ELT20X5.7-Z								3200±25%	1620±15%**
PC33ELT20X5.7-Z								3200±25%	
PC44ELT20X7.7-Z								4340±25%	80±3%
PC47ELT20X7.7-Z								4340±25%	125±3%
PC95ELT20X7.7-Z	0.469	25.6	54.6	1400	52.9	23.2	7.8	5630±25%	200±5%
PC50ELT20X7.7-Z								2800±25%	1560±15%**
PC33ELT20X7.7-Z								2800±25%	
PC44ELT22X6-Z								5750±25%	100±3%
PC47ELT22X6-Z								5750±25%	160±3%
PC95ELT22X6-Z	0.351	23.4	66.6	1560	64.2	12.8	9.0	7250±25%	250±5%
PC50ELT22X6-Z								3800±25%	1910±15%**
PC33ELT22X6-Z								3800±25%	
PC44ELT22X8-Z								5280±25%	100±3%
PC47ELT22X8-Z								5280±25%	160±3%
PC95ELT22X8-Z	0.413	27.3	66.2	1810	64.2	25.5	10	6540±25%	250±5%
PC50ELT22X8-Z								3240±25%	1850±15%**
PC33ELT22X8-Z								3240±25%	

* AL-value: 1kHz, 0.5mA, 100Ts

** Only PC95 material

ELT CORES

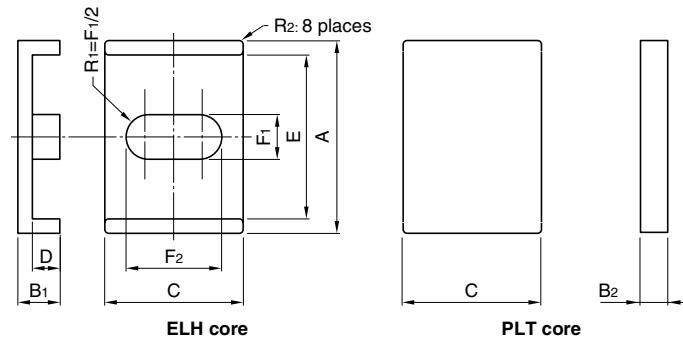
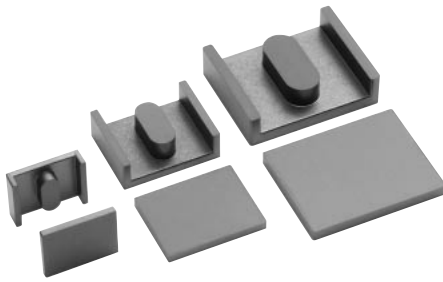

Part No. (ELH+PLT)	Dimensions in								
	A	B1	B2	C	D	E	F1	F2	R2
PC44ELT25X6.6-Z									
PC47ELT25X6.6-Z	25.00±0.45	4.29±0.10	2.29±0.10	20.00±0.35	2.00±0.10	20.83±0.35	6.32±0.15	14.54±0.25	0.50
PC95ELT25X6.6-Z	.984±.018	.169±.004	.090±.004	.787±.014	.079±.004	.820±.014	.249±.006	.572±.010	.020
PC50ELT25X6.6-Z									
PC33ELT25X6.6-Z									
PC44ELT25X8.6-Z									
PC47ELT25X8.6-Z	25.00±0.45	6.29±0.15	2.29±0.10	20.00±0.35	4.00±0.15	20.83±0.35	6.32±0.15	14.54±0.25	0.50
PC95ELT25X8.6-Z	.984±.018	.248±.006	.090±.004	.787±.014	.157±.006	.820±.014	.249±.006	.572±.010	.020
PC50ELT25X8.6-Z									
PC33ELT25X8.6-Z									

Part No. (ELH+PLT)	Effective parameter							Electrical characteristics	
	C1	$\varnothing e$	Ae	Ve	Amin.	Acw	Wt	AL-value (nH/N ²)*	
	(mm ⁻¹)	(mm)	(mm ²)	(mm ³)	(mm ²)	(mm ²)	(g)	Without air gap	With air gap
PC44ELT25X6.6-Z								7000±25%	
PC47ELT25X6.6-Z								7000±25%	100±3%
PC95ELT25X6.6-Z	0.302	26.0	86.0	2230	83.0	14.5	13	8600±25%	160±3%
PC50ELT25X6.6-Z								4600±25%	250±5%
PC33ELT25X6.6-Z								4600±25%	2430±15%**
PC44ELT25X8.6-Z								6110±25%	
PC47ELT25X8.6-Z								6110±25%	100±3%
PC95ELT25X8.6-Z	0.350	30.0	85.6	2570	83.0	29.0	15	7540±25%	160±3%
PC50ELT25X8.6-Z								4090±25%	250±5%
PC33ELT25X8.6-Z								4090±25%	2340±15%**

* AL-value: 1kHz, 0.5mA, 100Ts

** Only PC95 material

PQI CORES

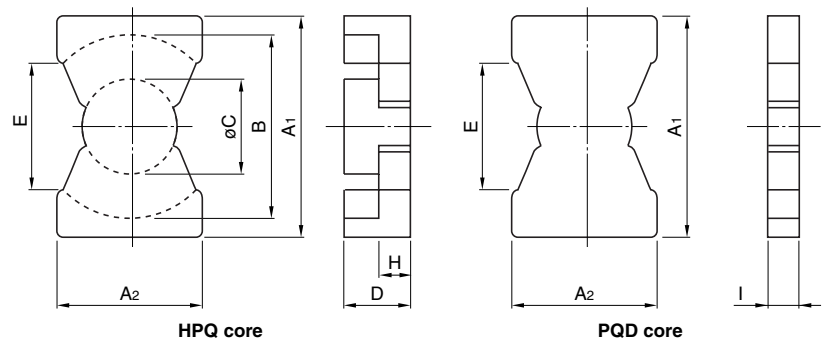
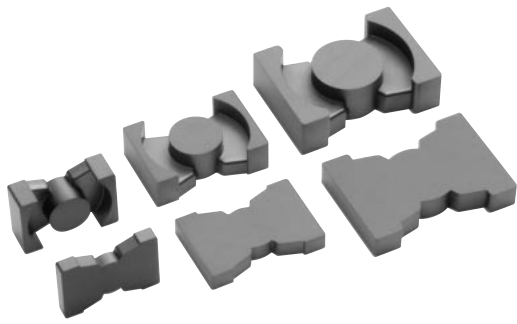

Part No. (HPQ+PQD)	Dimensions in		B	øC	D	E min.	H	I
	mm	inches						
PC44PQI16/7.8Z-12								
PC47PQI16/7.8Z-12	16.40±0.30	11.20±0.30	14.40±0.30	7.00±0.20	5.40±0.10	9.60	3.05±0.15	2.35±0.10
PC95PQI16/7.8Z-12	.646±.012	.441±.012	.567±.012	.276±.008	.213±.004	.378	.120±.006	.093±.004
PC50PQI16/7.8Z-12								
PC33PQI16/7.8Z-12								
PC44PQI20/9Z-12								
PC47PQI20/9Z-12	20.50±0.40	14.00±0.40	18.00±0.40	8.80±0.20	6.00±0.10	12.00	3.05±0.15	2.95±0.10
PC95PQI20/9Z-12	.807±.016	.551±.016	.709±.016	.346±.008	.236±.004	.472	.120±.006	.116±.004
PC50PQI20/9Z-12								
PC33PQI20/9Z-12								
PC44PQI26/12Z-12								
PC47PQI26/12Z-12	26.50±0.45	19.00±0.45	22.50±0.45	12.00±0.20	7.30±0.10	15.50	3.10±0.15	4.20±0.10
PC95PQI26/12Z-12	1.043±.018	.748±.018	.886±.018	.472±.008	.287±.004	.610	.122±.006	.165±.004
PC50PQI26/12Z-12								
PC33PQI26/12Z-12								

Part No. (HPQ+PQD)	Effective parameter							Electrical characteristics	
	C ₁ (mm ⁻¹)	l _e (mm)	A _e (mm ²)	V _e (mm ³)	A _{min} (mm ²)	A _{cw} (mm ²)	Wt (g)	AL-value (nH/N ²) [*]	
								Without air gap	With air gap
PC44PQI16/7.8Z-12								4100±25%	63±3%
PC47PQI16/7.8Z-12								4100±25%	100±5%
PC95PQI16/7.8Z-12	0.467	19.5	41.8	815	37.6	11.3	5.0	4910±25%	160±7%
PC50PQI16/7.8Z-12								2700±25%	1200±15%**
PC33PQI16/7.8Z-12								2700±25%	
PC44PQI20/9Z-12								5600±25%	100±3%
PC47PQI20/9Z-12								5600±25%	160±5%
PC95PQI20/9Z-12	0.346	22.9	66.0	1510	59.3	14.0	9.0	7070±25%	250±7%
PC50PQI20/9Z-12								3670±25%	1830±15%**
PC33PQI20/9Z-12								3670±25%	
PC44PQI26/12Z-12								9700±25%	100±3%
PC47PQI26/12Z-12								9700±25%	160±3%
PC95PQI26/12Z-12	0.224	27.7	123	3410	109	16.3	21	11950±25%	250±5%
PC50PQI26/12Z-12								6200±25%	3280±15%**
PC33PQI26/12Z-12								6200±25%	

* AL-value: 1kHz, 0.5mA, 100Ts

** Only PC95 material

EIR CORES

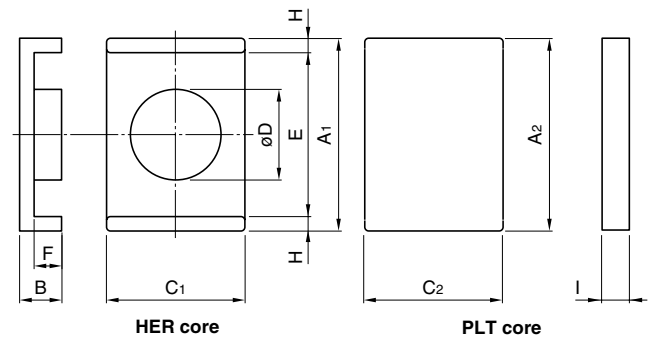
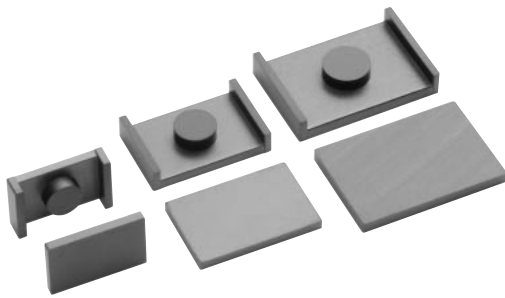

Part No. (HER+PLT)	Dimensions in		C ₁	øD	E	F	H	A ₂	C ₂	I
	A ₁	B								
PC44EIR14/4.5/9-Z										
PC47EIR14/4.5/9-Z	13.85±0.25	3.20±0.10	9.00±0.20	5.20±0.10	11.35±0.15	1.90±0.10	1.25	14.00±0.20	9.20±0.20	1.30±0.10
PC95EIR14/4.5/9-Z	.545±.010	.126±.004	.354±.008	.205±.004	.447±.006	.075±.004	.049	.551±.008	.362±.008	.051±.004
PC50EIR14/4.5/9-Z										
PC33EIR14/4.5/9-Z										
PC44EIR18/5/12-Z										
PC47EIR18/5/12-Z	18.15±0.30	3.50±0.10	12.00±0.20	6.00±0.10	15.75±0.25	2.00±0.10	1.20	18.20±0.25	12.20±0.20	1.50±0.10
PC95EIR18/5/12-Z	.715±.012	.138±.004	.472±.008	.236±.004	.620±.010	.079±.004	.047	.717±.010	.480±.008	.059±.004
PC50EIR18/5/12-Z										
PC33EIR18/5/12-Z										
PC44EIR22/5.5/15-Z										
PC47EIR22/5.5/15-Z	22.10±0.35	3.75±0.10	15.25±0.25	6.80±0.10	19.70±0.30	2.00±0.10	1.20	22.20±0.30	15.50±0.20	1.75±0.10
PC95EIR22/5.5/15-Z	.870±.014	.148±.004	.600±.010	.268±.004	.776±.012	.079±.004	.047	.874±.012	.610±.008	.069±.004
PC50EIR22/5.5/15-Z										
PC33EIR22/5.5/15-Z										

Part No. (HER+PLT)	Effective parameter							Electrical characteristics	
	C ₁	ℓ _e	A _e	V _e	A _{min}	A _{cw}	W _t	AL-value (nH/N ²)	
	(mm ⁻¹)	(mm)	(mm ²)	(mm ³)	(mm ²)	(mm ²)	(g)	Without air gap	With air gap
PC44EIR14/4.5/9-Z								2400±25%	
PC47EIR14/4.5/9-Z								2400±25%	63±3%
PC95EIR14/4.5/9-Z	0.679	15.4	22.7	349	21.2	5.84	2.0	3020±25%	100±5%
PC50EIR14/4.5/9-Z								1800±25%	160±7%
PC33EIR14/4.5/9-Z								1800±25%	680±15%**
PC44EIR18/5/12-Z								2900±25%	
PC47EIR18/5/12-Z								2900±25%	80±3%
PC95EIR18/5/12-Z	0.601	19.7	32.8	645	28.3	9.75	3.8	3690±25%	125±5%
PC50EIR18/5/12-Z								2100±25%	200±7%
PC33EIR18/5/12-Z								2100±25%	890±15%**
PC44EIR22/5.5/15-Z								3400±25%	
PC47EIR22/5.5/15-Z								3400±25%	80±3%
PC95EIR22/5.5/15-Z	0.505	23.2	46.1	1070	36.3	12.9	6.5	4550±25%	125±5%
PC50EIR22/5.5/15-Z								2500±25%	200±7%
PC33EIR22/5.5/15-Z								2500±25%	1130±15%**

* AL-value: 1kHz, 0.5mA, 100Ts

** Only PC95 material

ER CORES

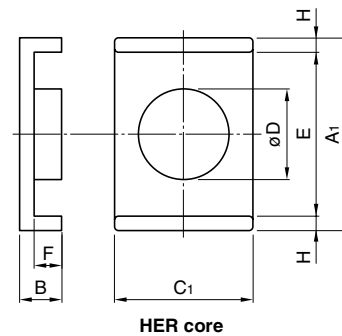
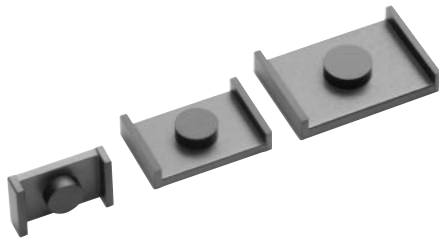

HER core

Part No. (HER+HER)	Dimensions in		C ₁	øD	E	F	H
	mm	inches					
PC44ER14/4.5/9-Z							
PC47ER14/4.5/9-Z	13.85±0.25	2.25±0.10	9.00±0.20	5.20±0.10	11.35±0.15	0.95±0.10	1.25
PC95ER14/4.5/9-Z	.545±.010	.089±.004	.354±.008	.205±.004	.447±.006	.037±.004	.049
PC50ER14/4.5/9-Z							
PC33ER14/4.5/9-Z							
PC44ER18/5/12-Z							
PC47ER18/5/12-Z	18.15±0.30	2.50±0.10	12.00±0.20	6.00±0.10	15.75±0.25	1.00±0.10	1.20
PC95ER18/5/12-Z	.715±.012	.098±.004	.472±.008	.236±.004	.620±.010	.039±.004	.047
PC50ER18/5/12-Z							
PC33ER18/5/12-Z							
PC44ER22/5.5/15-Z							
PC47ER22/5.5/15-Z	22.10±0.35	2.75±0.10	15.25±0.25	6.80±0.10	19.70±0.30	1.00±0.10	1.20
PC95ER22/5.5/15-Z	.870±.014	.108±.004	.600±.010	.268±.004	.776±.012	.039±.004	.047
PC50ER22/5.5/15-Z							
PC33ER22/5.5/15-Z							
PC44ER25/5.5/18-Z							
PC47ER25/5.5/18-Z	25.30±0.40	2.75±0.10	18.00±0.40	7.00±0.15	22.90±0.40	1.00±0.10	1.20
PC95ER25/5.5/18-Z	.996±.016	.108±.004	.709±.016	.276±.006	.902±.016	.039±.004	.047
PC50ER25/5.5/18-Z							
PC33ER25/5.5/18-Z							

Part No. (HER+HER)	Effective parameter							Electrical characteristics	
	C ₁	∅e	A _e	V _e	A _{min.}	A _{cw}	Wt	AL-value (nH/N ²)*	
	(mm ⁻¹)	(mm)	(mm ²)	(mm ³)	(mm ²)	(mm ²)	(g)	Without air gap	With air gap
PC44ER14/4.5/9-Z								2400±25%	
PC47ER14/4.5/9-Z								2400±25%	63±3%
PC95ER14/4.5/9-Z	0.679	15.4	22.7	349	21.2	5.84	2.0	3020±25%	100±5%
PC50ER14/4.5/9-Z								1800±25%	160±7%
PC33ER14/4.5/9-Z								1800±25%	680±15%**
PC44ER18/5/12-Z								2900±25%	
PC47ER18/5/12-Z								2900±25%	80±3%
PC95ER18/5/12-Z	0.601	19.7	32.8	645	28.3	9.75	3.8	3690±25%	125±5%
PC50ER18/5/12-Z								2100±25%	200±7%
PC33ER18/5/12-Z								2100±25%	890±15%**
PC44ER22/5.5/15-Z								3400±25%	
PC47ER22/5.5/15-Z								3400±25%	80±3%
PC95ER22/5.5/15-Z	0.505	23.2	46.1	1070	36.3	12.9	6.5	4550±25%	125±5%
PC50ER22/5.5/15-Z								2500±25%	200±7%
PC33ER22/5.5/15-Z								2500±25%	1130±15%**
PC44ER25/5.5/18-Z								3600±25%	
PC47ER25/5.5/18-Z								3600±25%	80±3%
PC95ER25/5.5/18-Z	0.486	26.1	53.7	1400	38.5	15.9	8.5	4640±25%	125±3%
PC50ER25/5.5/18-Z								2600±25%	200±5%
PC33ER25/5.5/18-Z								2600±25%	1140±15%**

* AL-value: 1kHz, 0.5mA, 100Ts

** Only PC95 material

EI CORES

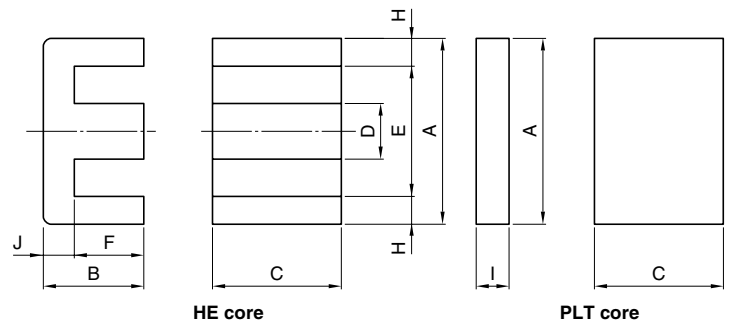
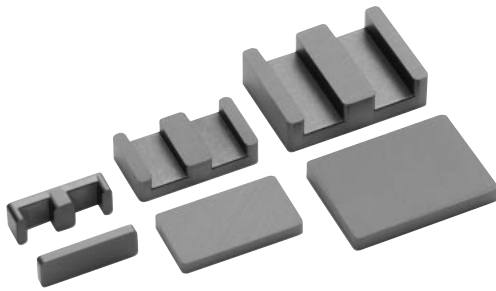

Part No. (HE+PLT)	Dimensions in		C	D	E	F	H	I	J
	A	B							
PC44EI14/5/5-Z									
PC47EI14/5/5-Z	14.00±0.30	3.50±0.10	5.00±0.10	3.00±0.10	11.00±0.25	2.00±0.10	1.50	1.50±0.05	1.50
PC95EI14/5/5-Z	.551±.012	.138±.004	.197±.004	.118±.004	.433±.010	.079±.004	.059	.059±.002	.059
PC50EI14/5/5-Z									
PC33EI14/5/5-Z									
PC44EI18/6/10-Z									
PC47EI18/6/10-Z	18.00±0.35	4.00±0.10	10.00±0.20	4.00±0.10	14.00±0.30	2.00±0.10	2.00	2.00±0.05	2.00
PC95EI18/6/10-Z	.709±.014	.157±.004	.394±.008	.157±.004	.551±.012	.079±.004	.079	.079±.002	.079
PC50EI18/6/10-Z									
PC33EI18/6/10-Z									
PC44EI22/8/16-Z									
PC47EI22/8/16-Z	21.80±0.40	5.70±0.10	15.80±0.30	5.00±0.10	16.80±0.40	3.20±0.10	2.50	2.50±0.05	2.50
PC95EI22/8/16-Z	.858±.016	.224±.004	.622±.012	.197±.004	.661±.016	.126±.004	.098	.098±.002	.098
PC50EI22/8/16-Z									
PC33EI22/8/16-Z									

Part No. (HE+PLT)	Effective parameter							Electrical characteristics	
	C ₁	ℓ _e	A _e	V _e	A _{min}	A _{cw}	Wt	AL-value (nH/N ²)*	
	(mm ⁻¹)	(mm)	(mm ²)	(mm ³)	(mm ²)	(mm ²)	(g)	Without air gap	With air gap
PC44EI14/5/5-Z								1500±25%	
PC47EI14/5/5-Z								1500±25%	63±3%
PC95EI14/5/5-Z	1.11	16.7	15.0	251	15.0	8.00	1.3	1970±25%	100±5%
PC50EI14/5/5-Z								1150±25%	160±7%
PC33EI14/5/5-Z								1150±25%	470±15%**
PC44EI18/6/10-Z								3800±25%	
PC47EI18/6/10-Z								3800±25%	100±3%
PC95EI18/6/10-Z	0.507	20.3	40.0	811	40.0	10.0	4.4	4720±25%	160±3%
PC50EI18/6/10-Z								2450±25%	250±5%
PC33EI18/6/10-Z								2450±25%	1220±15%**
PC44EI22/8/16-Z								6400±25%	
PC47EI22/8/16-Z								6400±25%	160±3%
PC95EI22/8/16-Z	0.330	26.1	79.0	2060	79.0	18.9	11	8010±25%	250±3%
PC50EI22/8/16-Z								4300±25%	315±3%
PC33EI22/8/16-Z								4300±25%	2300±15%**

* AL-value: 1kHz, 0.5mA, 100Ts

** Only PC95 material