

TOROIDAL CORES T SERIES

TDK toroidal cores find use in many kinds of device—pulse transformers, delay lines, R. F. coils, converter transformers, wideband transformers, impedance—matching transformers and the like. The variety of TDK materials, of which the TDK cores are made, provides a truly wide range of cores for the user's selection.

The core meeting user's requirement for duty anywhere between the audio range and about 20MHz will be readily found in the TDK toroidal core line.



ORDERING CODE SYSTEMS

For general use

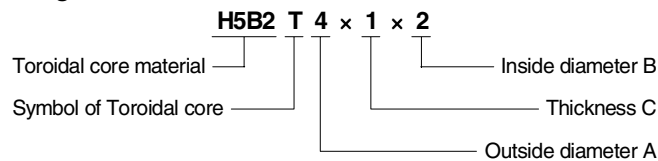

For LAN pulse transformers

(This ordering code system is used for only DNW45 items.)

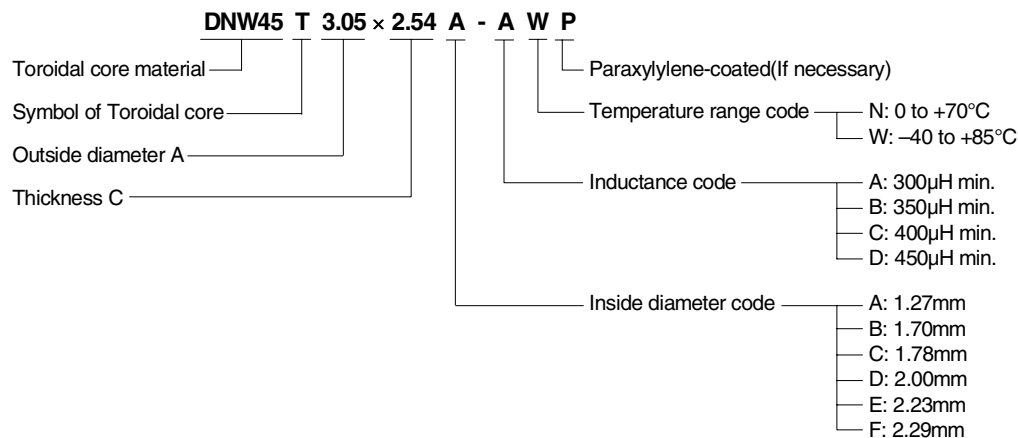

FOR GENERAL USE

DIMENSIONS/PARAMETERS AND AL-VALUE

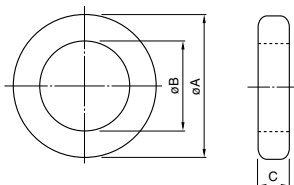

Type (øA×C×øB)	Dimensions in $\frac{\text{mm}}{\text{inches}}$			Parameters		
	øA	øB	C	C1 (mm ⁻¹)	Ae (mm ²)	ℓe (mm)
T3.05×1.27×1.27	3.05 .120	1.27 .050	1.27 .050	5.65	1.06	5.99
T4×1×2	4.00 .157	2.00 .079	1.00 .039	9.06	0.961	8.71
T3.94×1.27×2.23	3.94 .155	2.23 .088	1.27 .050	8.69	1.06	9.19
T4.83×1.27×2.29	4.83 .190	2.29 .090	1.27 .050	6.63	1.54	10.2
T6×1.5×3	6.00 .236	3.00 .118	1.50 .059	6.04	2.16	13.1
T5.84×1.52×3.05	5.84 .230	3.05 .120	1.52 .060	6.34	2.05	13.0
T8×2×4	8.00 .315	4.00 .157	2.00 .079	4.53	3.84	17.4
T10×2.5×5	10.0 .394	5.00 .197	2.50 .098	3.63	6.01	21.8
T12×3×6	12.0 .472	6.00 .236	3.00 .118	3.02	8.65	26.1
T14×3.5×7	14.0 .551	7.00 .276	3.50 .138	2.59	11.8	30.5

Type (øA×C×øB)	AL-value (nH/N ²)					
	HP5	H5B2	H5C3	PC40	H5A	H5C2
T3.05×1.27×1.27	1100±20%	1700±25%	3340±30%			
T4×1×2	670±20%	1000±25%	2000±30%			
T3.94×1.27×2.23	720±20%	1080±25%	2170±30%			
T4.83×1.27×2.29	950±20%	1400±25%	2840±30%			
T6×1.5×3	1000±20%	1500±25%	3000±30%			
T5.84×1.52×3.05	990±20%	1480±25%	2960±30%			
T8×2×4	1330±20%	2000±25%	4000±30%			
T10×2.5×5	1670±20%	2500±25%	5000±30%			
T12×3×6				1020±25%	1400±25%	3600±25%
T14×3.5×7				1200±25%	1650±25%	4200±25%

- Can be coated with epoxy or paraxyllylene.
- If epoxy or paraxyllylene-coated products are desired, please suffix P or E to part No. when ordering.
Above T10 (outside diameter 10mm min.): Epoxy Coating "E"
Up to T8 (outside diameter 8mm max.): Paraxyllylene "P"
- Insulation withstanding voltage of coating product: DC.1000V min. for 1 second.
- Measuring conditions:
HP5, H5B2, H5C2, H5C3: 10kHz, 10mV, 10Ts
PC40: 100kHz, 10mV, 10Ts
H5A: 50kHz, 10mV, 10Ts

Type (ϕ A \times C \times ϕ B)	Dimensions in $\frac{\text{mm}}{\text{inches}}$			Parameters		
	ϕ A	ϕ B	C	C1 (mm^{-1})	Ae (mm^2)	l_e (mm)
T20\times5\times10	20.0 .787	10.0 .394	5.00 .197	1.81	24.0	43.6
T20\times7.5\times14.5	20.0 .787	14.5 .571	7.50 .295	2.61	20.4	53.3
T28\times13\times16	28.0 1.102	16.0 .630	13.0 .512	0.864	76.0	65.6
T31\times8\times19	31.0 1.220	19.0 .748	8.00 .315	1.60	47.1	75.5
T38\times14\times22	38.0 1.496	22.0 .866	14.0 .551	0.821	109	89.7
T44.5\times13\times30	44.5 1.752	30.0 1.181	13.0 .512	1.23	93.0	114

Type (ϕ A \times C \times ϕ B)	AL-value (nH/N ²)					
	HP5	H5B2	H5C3	PC40	H5A	H5C2
T20\times5\times10				1750 \pm 25%	2350 \pm 25%	6000 \pm 30%
T20\times7.5\times14.5				1050 \pm 25%	1800 \pm 25%	4100 \pm 30%
T28\times13\times16						14000 \pm 30%
T31\times8\times19						7700 \pm 30%
T38\times14\times22						13160 \pm 30%
T44.5\times13\times30						10000 \pm 30%

- Can be coated with epoxy or paraxyllylene.
- If epoxy or paraxyllylene-coated products are desired, please suffix P or E to part No. when ordering.
Above T10 (outside diameter 10mm min.): Epoxy Coating "E"
Up to T8 (outside diameter 8mm max.): Paraxyllylene "P"
- Insulation withstanding voltage of coating product: DC.1000V min. for 1 second.
- Measuring conditions:
HP5, H5B2, H5C2, H5C3: 10kHz, 10mV, 10Ts
PC40: 100kHz, 10mV, 10Ts
H5A: 50kHz, 10mV, 10Ts

FOR LAN PULSE TRANSFORMERS

DIMENSIONS/PARAMETERS AND AL-VALUE

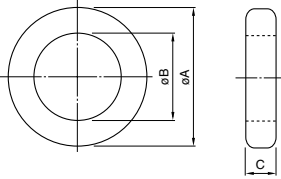

Type (øA×C×øB)	Dimensions in $\frac{\text{mm}}{\text{inches}}$			Parameters		
	øA	øB	C	C ₁ (mm ⁻¹)	A _e (mm ²)	l _e (mm)
T3.05×1.27A	3.05±0.2 .120±.008	1.27±0.2 .050±.008	1.27±0.2 .050±.008	5.65	1.06	5.99
T3.05×2.54A	3.05±0.2 .120±.008	1.27±0.2 .050±.008	2.54±0.2 .100±.008	2.82	2.12	5.99
T3.4×1.5B	3.40±0.2 .134±.008	1.70±0.2 .067±.008	1.50±0.2 .059±.008	6.04	1.23	7.40
T3.4×2.5B	3.40±0.2 .134±.008	1.70±0.2 .067±.008	2.50±0.2 .098±.008	3.63	2.04	7.40
T3.94×1.27C	3.94±0.2 .155±.008	1.78±0.2 .070±.008	1.27±0.2 .050±.008	6.23	1.30	8.10

Part No.	Number of turns								AL-value (nH/N ²)
	Temperature range code: N[0 to 70°C]				Temperature range code: W[-40 to +85°C]				
	Inductance code[at DC.8mA]				Inductance code[at DC.8mA]				
	A:300μH min.	B:350μH min.	C:400μH min.	D:450μH min.	A:300μH min.	B:350μH min.	C:400μH min.	D:450μH min.	
DNW45T3.05×1.27A-AN	26Ts	—	—	—	—	—	—	—	930±25%
DNW45T3.05×1.27A-BN	—	30Ts	—	—	—	—	—		
DNW45T3.05×1.27A-AW	—	—	—	—	30Ts	—	—		
DNW45T3.05×2.54A-AN	16Ts	—	—	—	—	—	—	1870±25%	
DNW45T3.05×2.54A-BN	—	18Ts	—	—	—	—	—		
DNW45T3.05×2.54A-DN	—	—	—	20Ts	—	—	—		
DNW45T3.05×2.54A-AW	—	—	—	—	16Ts	—	—		
DNW45T3.05×2.54A-BW	—	—	—	—	—	18Ts	—		
DNW45T3.05×2.54A-CW	—	—	—	—	—	—	20Ts		
DNW45T3.05×2.54A-DW	—	—	—	—	—	—	22Ts		
DNW45T3.4×1.5B-AN	24Ts	—	—	—	—	—	—	870±25%	
DNW45T3.4×1.5B-BN	—	26Ts	—	—	—	—	—		
DNW45T3.4×1.5B-CN	—	—	30Ts	—	—	—	—		
DNW45T3.4×1.5B-DN	—	—	—	32Ts	—	—	—		
DNW45T3.4×1.5B-AW	—	—	—	—	26Ts	—	—		
DNW45T3.4×1.5B-BW	—	—	—	—	—	28Ts	—		
DNW45T3.4×1.5B-CW	—	—	—	—	—	—	32Ts		
DNW45T3.4×2.5B-AN	18Ts	—	—	—	—	—	—	1460±25%	
DNW45T3.4×2.5B-BN	—	20Ts	—	—	—	—	—		
DNW45T3.4×2.5B-DN	—	—	—	22Ts	—	—	—		
DNW45T3.4×2.5B-AW	—	—	—	—	18Ts	—	—		
DNW45T3.4×2.5B-BW	—	—	—	—	—	20Ts	—		
DNW45T3.4×2.5B-CW	—	—	—	—	—	—	22Ts		
DNW45T3.4×2.5B-DW	—	—	—	—	—	—	24Ts		
DNW45T3.94×1.27C-AN	24Ts	—	—	—	—	—	—	850±25%	
DNW45T3.94×1.27C-BN	—	26Ts	—	—	—	—	—		
DNW45T3.94×1.27C-CN	—	—	30Ts	—	—	—	—		
DNW45T3.94×1.27C-DN	—	—	—	32Ts	—	—	—		
DNW45T3.94×1.27C-AW	—	—	—	—	24Ts	—	—		
DNW45T3.94×1.27C-BW	—	—	—	—	—	28Ts	—		
DNW45T3.94×1.27C-CW	—	—	—	—	—	—	30Ts		
DNW45T3.94×1.27C-DW	—	—	—	—	—	—	34Ts		

- Test conditions Inductance: 100kHz, Erms 100mV, DC.8mA,
AL-value: 100kHz, Erms 100mV, 10Ts, DC.0A, 25°C

- Can be coated with paraxyllylene(Thickness of coating: 12.5μm typ.). Please suffix "P" to the part number when ordering.
- Insulation withstanding voltage of coated product: DC.1000V min. for 1 second.

Type ($\phi A \times C \times \phi B$)	Dimensions in $\frac{\text{mm}}{\text{inches}}$			Parameters		
	ϕA	ϕB	C	C ₁ (mm ⁻¹)	A _e (mm ²)	ℓ _e (mm)
T3.94×1.78C	3.94±0.2 .155±.008	1.78±0.2 .070±.008	1.78±0.2 .070±.008	4.44	1.82	8.10
T3.94×1.27E	3.94±0.2 .155±.008	2.23±0.2 .088±.008	1.27±0.2 .050±.008	8.69	1.06	9.19
T3.94×1.78E	3.94±0.2 .155±.008	2.23±0.2 .088±.008	1.78±0.2 .070±.008	6.20	1.48	9.19
T4×1D	4.0±0.2 .157±.008	2.0±0.2 .079±.008	1.0±0.15 .039±.006	9.06	0.96	8.71
T4×2D	4.0±0.2 .157±.008	2.0±0.2 .079±.008	2.0±0.2 .079±.008	4.53	1.92	8.71
T4.83×1.27F	4.83±0.3 .190±.012	2.29±0.2 .090±.008	1.27±0.2 .050±.008	6.63	1.54	10.2

Part No.	Number of turns								AL-value (nH/N ²)
	Temperature range code: N [0 to 70°C]				Temperature range code: W [-40 to +85°C]				
	Inductance code[at DC.8mA]				Inductance code[at DC.8mA]				
	A:300μH min.	B:350μH min.	C:400μH min.	D:450μH min.	A:300μH min.	B:350μH min.	C:400μH min.	D:450μH min.	
DNW45T3.94×1.78C-AN	20Ts	—	—	—	—	—	—	—	1190±25%
DNW45T3.94×1.78C-BN	—	22Ts	—	—	—	—	—		
DNW45T3.94×1.78C-CN	—	—	24Ts	—	—	—	—		
DNW45T3.94×1.78C-DN	—	—	—	26Ts	—	—	—		
DNW45T3.94×1.78C-AW	—	—	—	—	20Ts	—	—	—	1190±25%
DNW45T3.94×1.78C-BW	—	—	—	—	—	22Ts	—	—	
DNW45T3.94×1.78C-CW	—	—	—	—	—	—	24Ts	—	
DNW45T3.94×1.78C-DW	—	—	—	—	—	—	—	26Ts	
DNW45T3.94×1.27E-AN	30Ts	—	—	—	—	—	—	—	610±25%
DNW45T3.94×1.27E-BN	—	34Ts	—	—	—	—	—	—	
DNW45T3.94×1.27E-CN	—	—	36Ts	—	—	—	—	—	
DNW45T3.94×1.27E-DN	—	—	—	40Ts	—	—	—	—	
DNW45T3.94×1.27E-AW	—	—	—	—	30Ts	—	—	—	610±25%
DNW45T3.94×1.27E-BW	—	—	—	—	—	34Ts	—	—	
DNW45T3.94×1.27E-CW	—	—	—	—	—	—	40Ts	—	
DNW45T3.94×1.78E-AN	24Ts	—	—	—	—	—	—	—	
DNW45T3.94×1.78E-BN	—	26Ts	—	—	—	—	—	—	
DNW45T3.94×1.78E-CN	—	—	28Ts	—	—	—	—	—	
DNW45T3.94×1.78E-DN	—	—	—	30Ts	—	—	—	—	
DNW45T3.94×1.78E-AW	—	—	—	—	26Ts	—	—	—	850±25%
DNW45T3.94×1.78E-BW	—	—	—	—	—	28Ts	—	—	
DNW45T3.94×1.78E-CW	—	—	—	—	—	—	30Ts	—	
DNW45T3.94×1.78E-DW	—	—	—	—	—	—	—	32Ts	
DNW45T4×1D-AN	30Ts	—	—	—	—	—	—	—	580±25%
DNW45T4×1D-BN	—	34Ts	—	—	—	—	—	—	
DNW45T4×1D-CN	—	—	38Ts	—	—	—	—	—	
DNW45T4×1D-AW	—	—	—	—	32Ts	—	—	—	
DNW45T4×1D-BW	—	—	—	—	—	36Ts	—	—	
DNW45T4×2D-AN	20Ts	—	—	—	—	—	—	—	1160±25%
DNW45T4×2D-BN	—	22Ts	—	—	—	—	—	—	
DNW45T4×2D-CN	—	—	24Ts	—	—	—	—	—	
DNW45T4×2D-DN	—	—	—	26Ts	—	—	—	—	
DNW45T4×2D-AW	—	—	—	—	20Ts	—	—	—	1160±25%
DNW45T4×2D-BW	—	—	—	—	—	22Ts	—	—	
DNW45T4×2D-CW	—	—	—	—	—	—	24Ts	—	
DNW45T4×2D-DW	—	—	—	—	—	—	—	26Ts	
DNW45T4.83×1.27F-AN	24Ts	—	—	—	—	—	—	—	800±25%
DNW45T4.83×1.27F-BN	—	26Ts	—	—	—	—	—	—	
DNW45T4.83×1.27F-CN	—	—	28Ts	—	—	—	—	—	
DNW45T4.83×1.27F-DN	—	—	—	30Ts	—	—	—	—	
DNW45T4.83×1.27F-AW	—	—	—	—	26Ts	—	—	—	800±25%
DNW45T4.83×1.27F-BW	—	—	—	—	—	28Ts	—	—	
DNW45T4.83×1.27F-CW	—	—	—	—	—	—	30Ts	—	
DNW45T4.83×1.27F-DW	—	—	—	—	—	—	—	32Ts	

• Test conditions Inductance: 100kHz, Erms 100mV, DC.8mA,

AL-value: 100kHz, Erms 100mV, 10Ts, DC.0A, 25°C

• Can be coated with paraxylylene(Thickness of coating: 12.5μm typ.). Please suffix "P" to the part number when ordering.

• Insulation withstanding voltage of coated product: DC.1000V min. for 1 second.

• All specifications are subject to change without notice.

The attached diagram indicates the relationship between flux density (ΔB) and field intensity (H) under impressed pulse voltage. Therefore, pulse inductance (L_p), pulse permeability (μ_p) and core shape values are obtainable as shown on the diagram.

HOW TO OBTAIN PULSE INDUCTANCE(L_p) AND PERMEABILITY (μ_p):

Given the impressed voltage E (V), pulse width τ (sec.) and number of turns N (t), the excitation current i_p (A) is obtained if the core shape is determined. Next, as the excitation current i_p is now known, the values for L_p and μ_p are obtained from the following formulas. Here, the values for ΔB and H are obtained from the attached graph:

$$\Delta B = \frac{E \cdot \tau}{N \cdot A_e} \times 10^9 \text{ (mT)} \quad i_p = \frac{H \cdot \ell_e}{N} \text{ (A)} \quad \mu_p = \frac{L_p \cdot \ell_e}{4\pi N^2 A_e} \times 10^{10}$$

$$H = \frac{N \cdot i_p}{\ell_e} \times 10^3 \text{ (A/m)} \quad L_p = \frac{E \cdot \tau}{i_p} \text{ (H)}$$

Example: Pulse inductance L_p and pulse permeability μ_p will be obtained as follows if pulse impression voltage E equals 5V, pulse width τ equals 2 μ sec., number of turns N equals 20 turns, and assuming the Toroidal core T6 \times 1.5 \times 3 of 5000 permeability is used. ($A_e=2.16\text{mm}^2$, $\ell_e=13.1\text{mm}$)

$$\Delta B = \frac{5 \times 2 \times 10^{-6}}{20 \times 2.2} \times 10^9 = 227 \text{ mT}$$

Therefore, H equals 51A/m can be read from the intersection of the curves for ΔB equals 227mT and HP5. Consequently, the excitation current i_p will be:

$$i_p = \frac{51 \times 13.1}{20} = 33.4 \text{ mA}$$

The values for L_p and μ_p will then be: $L_p = \frac{5 \times 2 \times 10^{-6}}{33.4 \times 10^{-3}} = 330 \mu\text{H}$ $\mu_p = \frac{0.30 \times 10^{-3} \times 13.1}{4\pi \cdot 20^2 \cdot 2.2} \times 10^{10} = 3555$

HOW CORE IS SHAPED:

Assuming, from the design standpoint, that the magnetic flux value ΔB has been confirmed; if material of known qualities is used, the field intensity H can be obtained from the graph. If the values of impressed voltage E (V), pulse width τ (sec.) and excitation current i_p are known, optimum core shape is obtained through the value of ℓ_e/A_e as given by the following formula as long as the number or turns N is determined.

$$\frac{\ell_e}{A_e} = \frac{N^2 \cdot i_p}{E \cdot \tau} \cdot \frac{\Delta B}{H} \cdot 10^{-6}$$

When magnetic flux density ΔB equals 227mT, field intensity H equals 51A/m, E equals 5V, τ equals 2 μ sec., i_p equals 33.4mA and N equals 20 turns, and if Toroidal HP 4,000 cores are used, the value ℓ_e/A_e for optimum cores will be:

$$\frac{\ell_e}{A_e} = \frac{20^2 \times 33.4 \times 10^{-3}}{5 \times 2 \times 10^{-6}} \times \frac{227 \times 10^{-6}}{51} = 5.95 \text{ mm}^{-1}$$

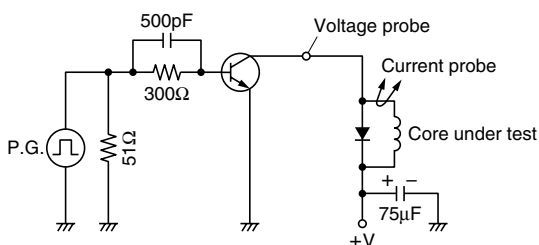

Fig.1 Test circuit

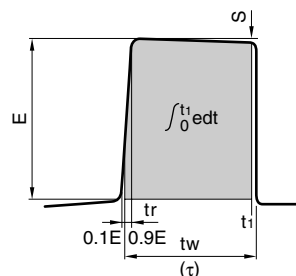

Fig.2 Pulse waveform

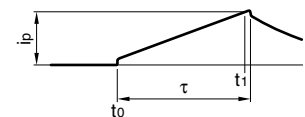
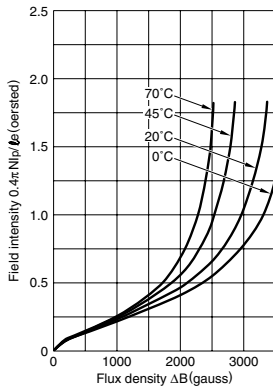

Fig.3 Current waveform

TYPICAL PULSE DRIVEN CHARACTERISTICS

HP5



H5B2

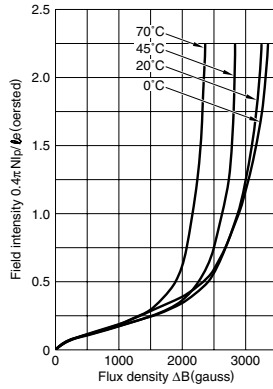

TYPICAL TEMPERATURE CHARACTERISTICS OF PULSE DRIVING

HP5

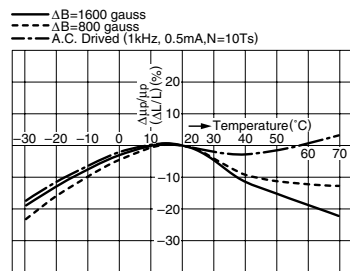

Test condition
 Pulse width: 2μsec.
 Repetition frequency 10kHz

H5B2

- 1. H5B2T2×4×1 (— $\mu_p=6500$ at 20°C, $\Delta B=850$ gauss
 - - - $\mu_p=5550$ at 20°C, $\Delta B=1700$ gauss
 $\mu_i=6300$)
- 2. H5B2T3×6×1.5 (— $\mu_p=6550$ at 20°C, $\Delta B=850$ gauss
 - - - $\mu_p=5900$ at 20°C, $\Delta B=1700$ gauss
 $\mu_i=6300$)

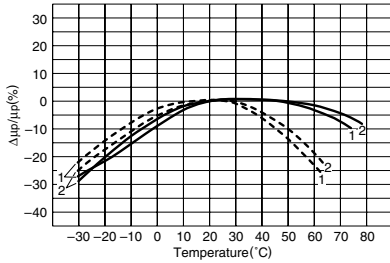

Test condition
 Pulse width: 2μsec.
 Repetition frequency 5kHz

H5C2

- $\Delta B=1000$ gauss
- - - $\Delta B=500$ gauss
- · - A.C. Drived (1kHz, 0.5mA, N=10Ts)

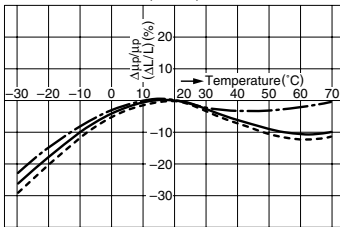

Test condition
 Pulse width: 2μsec.
 Repetition frequency 10kHz

This is indicated as the standardized value per turn of the typical frequency characteristic of the parallel resistance. Parallel resistance R_p of a chosen material and core size at certain frequency can be calculated by the following formula:

$$R_p = \frac{\text{Reading from the graph of } C_1 \cdot R_p / N^2}{C_1 \text{ of the chosen core}} \times N^2 (\Omega)$$

And C_1 means core factor l_e/A_e (mm^{-1}). Those for non-standard cores are calculated by the following formula:

$$C_1 = \frac{2\pi}{C \cdot \ln \frac{A}{B}}$$

where, A : outside diameter (mm)

B : inside diameter (mm)

C : thickness (mm)

Parallel resistance is related to series resistance by the following formula.

$$R_s = \frac{R_p}{(1+2)} (\Omega)$$

H5B2

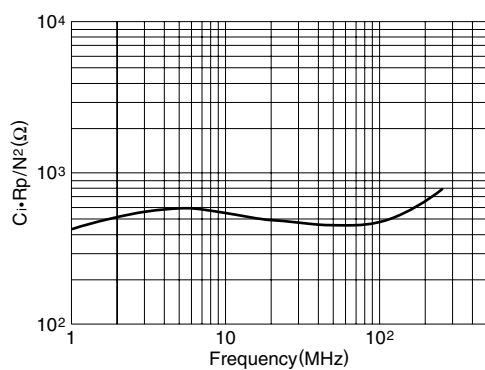

HP5

